

Challenge**Three**

Ring the sets that show three books. Write the number 3.

1.

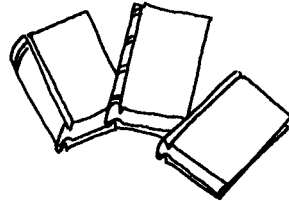
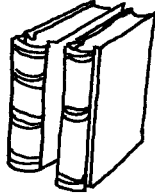
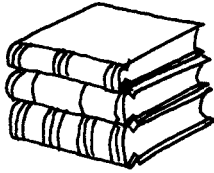

2.

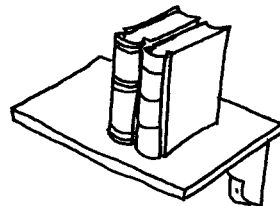
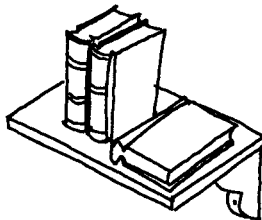
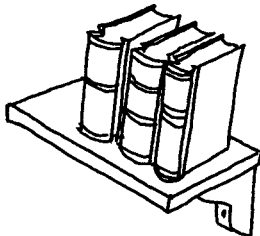

3.

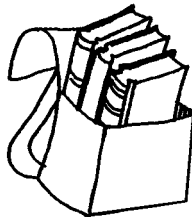
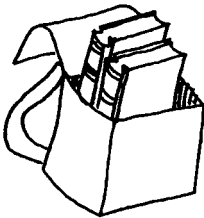

4.

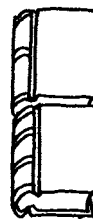
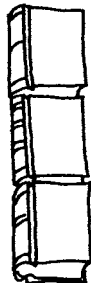
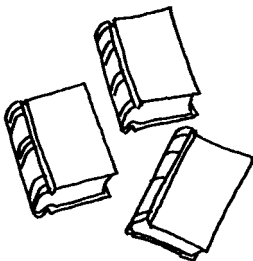

Challenge**Three**

Ring the sets that show three books. Write the number 3.

1.

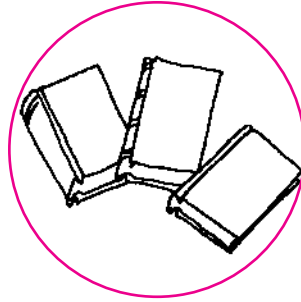
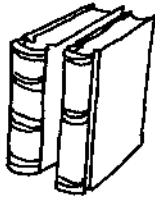

3

2.

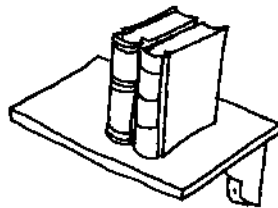
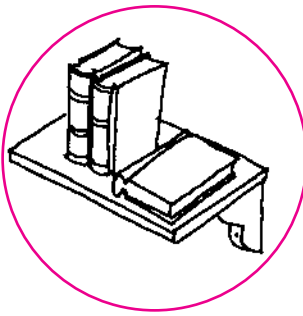
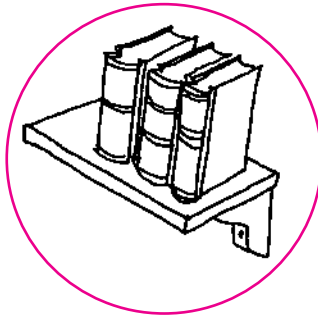

3

3.

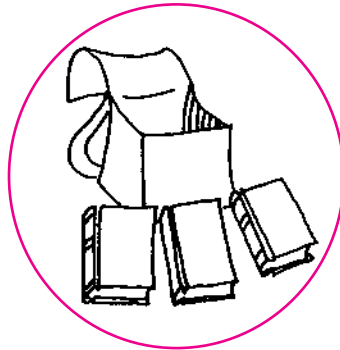
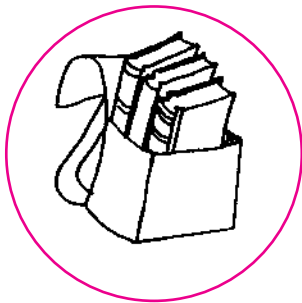
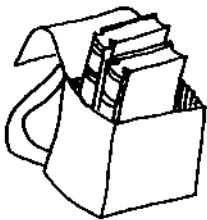

3

4.

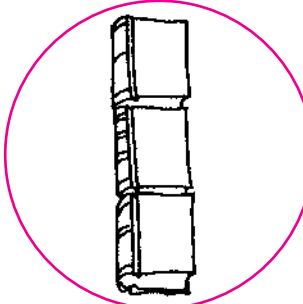
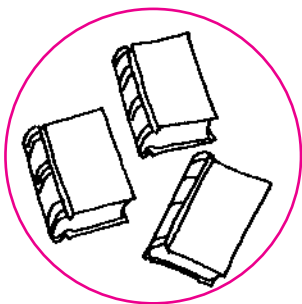

3